

**S P E C F I L E**

Product Number : **PT-VZ580**

Product Name : LCD Projectors

LCD Projectors

Specifications

Main unit

Power supply		AC 120 V , 50 Hz/60 Hz (For North America) AC 100 V - 240 V, 50 Hz/60 Hz (For other countries)
Power consumption*1		400 W (North America), 410 W (other countries) When [STANDBY MODE] is set to [ECO] : approx. 0.3 W (North America, Taiwan), approx. 0.5 W (Other countries) When [STANDBY MODE] is set to [NORMAL] and [IN STANDBY MODE] of [AUDIO SETTING] is set to [OFF]: approx. 12 W
BTU value		1,365 BTU (North America), 1,399 BTU (Other countries)
LCD panel	Panel size	16.3 mm (0.64 inches) diagonal (16:10 aspect ratio)
	Display method	Transparent LCD panel (× 3, R/G/B)
	Drive method	Active matrix method
	Pixels	2,304,000 (1920 × 1200) × 3, total of 6,912,000 pixels
Lens		Manual zoom (1.6×), manual focus, F 1.6–2.12, f 15.30–24.64 mm
	Throw ratio	1.09–1.77:1
Lamp		280 W UHM lamp
Projection size		0.76–7.62 m (30–300 inches) diagonally, 16:10 aspect ratio
Colors		Full color (16,777,216 colors)
Light output *2		5,000 lumens (Lamp power: Normal, Dynamic mode, Iris off, Daylight View:off, Auto Power Save:off)
Center-to-corner uniformity		85%
Contrast ratio*2		16,000:1(all white/all black, Image mode:Dynamic, Lamp power: Normal, Iris: On)
Resolution		1920 × 1200 pixels (Input signals that exceed this resolution will be converted to 1920 × 1200 pixels.)
Lamp replacement cycle		Normal: 5,000 hours, Eco1: 6,000 hours, Eco2: 7,000 hours
Filter replacement cycle		7,000 hours (Period varies depending on usage environment. It can be washed and reused up to 2 times.)
Scanning frequency	HDMI	<ul style="list-style-type: none"> <li>•Moving image signal resolution: 480i (525i)*3, 576i (625i)*3, 480p (525p), 576p (625p), 720 (750)/60p, 720 (750)/50p, 1080 (1125)/60i, 1080 (1125)/50i, 1080 (1125)/25p, 1080 (1125)/24p, 1080 (1125)/24sF, 1080 (1125)/30p, 1080 (1125)/60p, 1080 (1125)/50p</li> <li>Still image signal resolution: 640 x 400 to 1920 x 1200 (non-interlace)</li> <li>•Dot clock frequency: 25 MHz to 162 MHz</li> </ul>
	RGB	fH: 15- 91kHz, fV: 24 - 100Hz, dot clock: 162 MHz or less
	YPbPr (YCbCr)	480i (525i): fH 15.73 kHz; fV 59.94 Hz, 576i (625i): fH 15.63 kHz; fV 50 Hz, 480p (525p): fH 31.47 kHz; fV 59.94 Hz, 576p (625p): fH 31.25 kHz; fV 50 Hz, 720 (750)/60p: fH 45.00 kHz; fV 60 Hz, 720 (750)/50p: fH 37.50 kHz; fV 50 Hz, 1080 (1125)/60i: fH 33.75 kHz; fV 60 Hz, 1080 (1125)/50i: fH 28.13 kHz; fV 50 Hz, 1080 (1125)/25p: fH 28.13 kHz; fV 25 Hz, 1080 (1125)/24p: fH 27.00 kHz; fV 24 Hz, 1080 (1125)/24sF: fH 27.00 kHz; fV 48 Hz, 1080 (1125)/30p: fH 33.75 kHz; fV 30 Hz, 1080 (1125)/60p: fH 67.50 kHz; fV 60 Hz, 1080 (1125)/50p: fH 56.25 kHz; fV 50 Hz
	Video	fH: 15.73 kHz / 15.63 kHz fV: 59.94 Hz / 50 Hz [NTSC/NTSC4.43/PAL/PAL60/PAL-N/PAL-M/SECAM]
Installation		CEILING/DESK/AUTO, FRONT/REAR
Speaker		4.0 cm round-type x 1
Maximum usable volume output		10 W (monaural)

LCD Projectors

Keystone correction range

Only [KEYSTONE] used		[KEYSTONE] and [CURVED] used together				Only [CURVED] used	
Vertical keystone correction angle $\alpha$ (°)	Horizontal keystone correction angle $\beta$ (°)	Vertical keystone correction angle $\alpha$ (°)	Horizontal keystone correction angle $\beta$ (°)	Min. value of R2/L2	Min. value of R3/L3	Min. value of R2/L2	Min. value of R3/L3
±25	±30	±20	±15	1.4	2.9	0.7	1.6

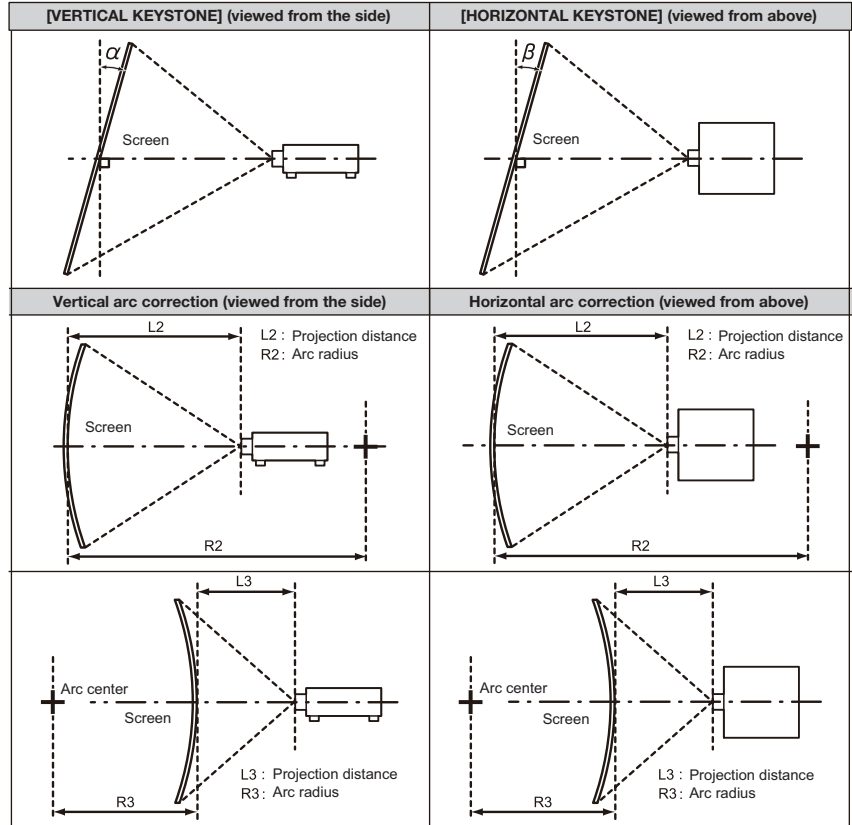

Optical axis shift

Vertical 0 – +44% from center of screen (manual)

U/D ratio 17:1 (when on top end)

Terminals

COMPUTER 1 IN

high-density D-Sub 15 p (female)

[RGB signal] R: 0.7 Vp-p, 75 ohms, G: 0.7 Vp-p (G: 1.0 Vp-p for sync on G), 75 ohms, B: 0.7 Vp-p, 75 ohms HD, VD/SYNC: TTL, high impedance, positive/negative automatic

[YPBPR signal] Y: 1.0 Vp-p (including sync signal), PB/PR (CB/CR): 0.7 Vp-p, 75 ohms

COMPUTER 2 IN / 1 OUT

high-density D-Sub 15 p (female)

[RGB signal] R: 0.7 Vp-p, 75 ohms, G: 0.7 Vp-p (G: 1.0 Vp-p for sync on G), 75 ohms, B: 0.7 Vp-p, 75 ohms HD, VD/SYNC: TTL, high impedance, positive/negative automatic

[YPBPR signal] Y: 1.0 Vp-p (including sync signal), PB/PR (CB/CR): 0.7 Vp-p, 75 ohms

VIDEO IN

Pin jack 1.0 Vp-p, 75 ohms

HDMI 1 IN

HDMI 19 pin, HDCP and Deep color compatible

Audio signals : Linear PCM (Sample frequency : 48 kHz/44.1 kHz/32 kHz)

HDMI 2 IN

HDMI 19 pin, HDCP and Deep color compatible

Audio signals : Linear PCM (Sample frequency : 48 kHz/44.1 kHz/32 kHz)

AUDIO IN 1

M3 stereo mini jack, 0.5 V[rms], input impedance 22 k ohms and more

AUDIO IN 2

M3 stereo mini jack, 0.5 V[rms], input impedance 22 k ohms and more

AUDIO IN 3

Pin jack x 2(L-R), 0.5 V[rms], input impedance 22 k ohms and more

VARIABLE AUDIO OUT

M3 stereo mini jack, 0 V[rms] to 2.0 V[rms] variable, output impedance 2.2 k ohms and less

USB A (DC OUT)

USB connector (type A)

SERIAL IN

D-sub 9 pin, RS-232C compliant, for computer control use

LAN

RJ-45, for network, PLink™ compatible, 100Base-TX

LCD Projectors

Power cord length		3.0 m(9 ft 10 in)(India), 2.0 m(6 ft 7 in)(Other countries)
Cabinet materials		Molded plastic
Dimensions (W × H × D)		389 × 125* <sup>4</sup> × 332mm (15-5/16 × 4-29/32* <sup>4</sup> × 13-1/16inches)
Weight* <sup>5</sup>		Approx. 4.9 kg (10.8 lbs)
Noise level* <sup>2</sup>		37dB (LAMP POWER: NORMAL/ECO1), 29dB (LAMP POWER: ECO2)
Operating environment	Temperature * <sup>6</sup>	0°C (32°F) to 40°C (104°F) (Elevation: below 1,200 m (3,937')) 0°C (32°F) to 30°C (86°F) (Elevation: 1,200 m (3,937') - 2,700m (8,858'))
	Humidity	20% to 80% (no condensation)

**Remote control unit**

Power supply	DC 3 V (AAA/R03/LR03 battery × 2)
Operation range	Approx. 7 m (23 ft) when operated from directly in front of the signal receptor
Dimensions (W × H × D)	44 × 105 × 20.5 mm (1-23/32" × 4-1/8" × 13/16")
Weight	Approx. 63g (2.22 ozs.) (including batteries)

**Other Applications**

Monitoring and Control Software <Bundle>  
Logo Transfer Software <Bundle>

**Supplied accessories**

Power code : Europe and Asia model (x 2), Other countries (x 1)  
Batteries for remote control unit (x 2) (R03/LR03/AAA type)  
Lens cap (x 1)  
String for lens cap (x 1)  
Application Guide (x 1)  
Software CD-ROM (x 1)  
(Operating instructions, Multi Projector Monitoring and Control Software, Logo Transfer Software)

**Optional accessories**

Ceiling Mount Bracket	for High ceilings	ET-PKL100H
Ceiling Mount Bracket	for Low ceilings	ET-PKL100S
Ceiling Mount Bracket	Projector Mount Bracket	ET-PKV400B
Replacement Lamp Unit		ET-LAV400
Replacement Filter Unit		ET-RFV410
Early Warning Software		ET-SWA100 series

Weights and dimensions shown are approximate. Specifications subject to change without notice.

- \*1 When the Standby mode is set to Eco, network functions such as power on over the LAN network will not operate. Also, only certain commands can be received for external control using the serial terminal.
- \*2 Measurement, measuring conditions, and method of notation all comply with ISO 21118 international standards.
- \*3 Only compatible with dot clock frequency of 27 MHz (pixel repetition signal) for 480i(525i) and 576i(625i)
- \*4 When adjustable feet shortened.
- \*5 Average value. May differ depending on models.
- \*6 If [LAMP POWER] set to [NORMAL], [LAMP MODE] will be switched to [ECO1] automatically when the operating environment temperature is 35°C (95°F) to 40°C (104°F).

Dimensions

unit : mm (inch)

NOTE: This illustration is not drawn to scale.

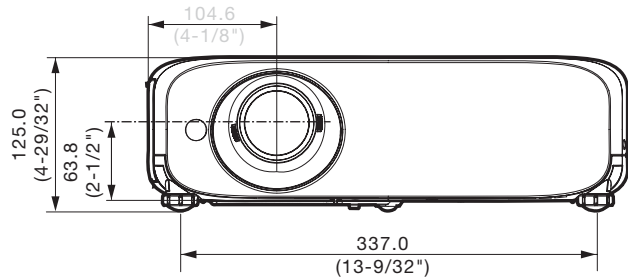
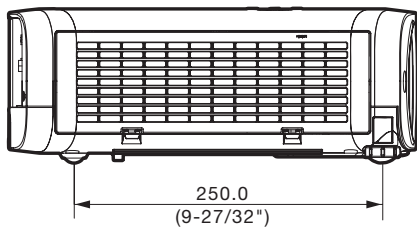
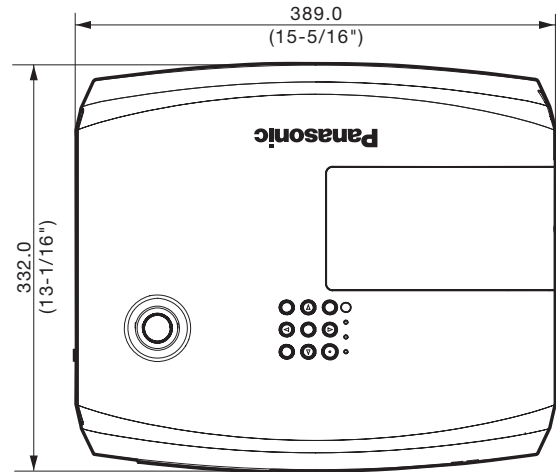

Terminals

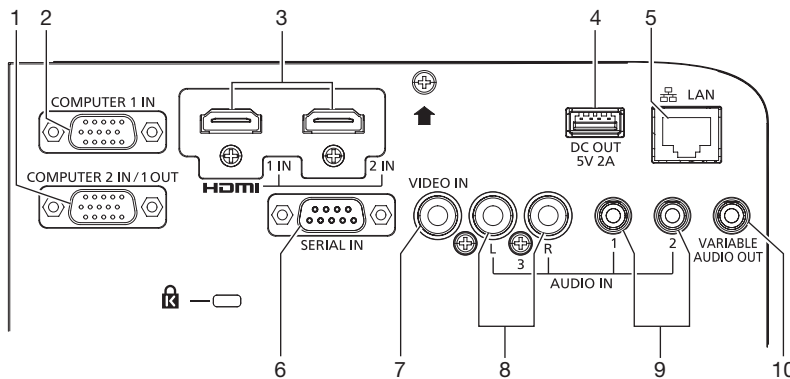

- |  |                                 |
|--|---------------------------------|
| 1 Computer 2 input / computer 1 output | 6 Serial input                  |
| 2 Computer 1 input                     | 7 Video input                   |
| 3 HDMI input 1 / HDMI input 2          | 8 Audio input 3                 |
| 4 USB connector (DC OUT)               | 9 Audio input 1 / Audio input 2 |
| 5 LAN connector                        | 10 Audio output                 |

Standard setting-up position

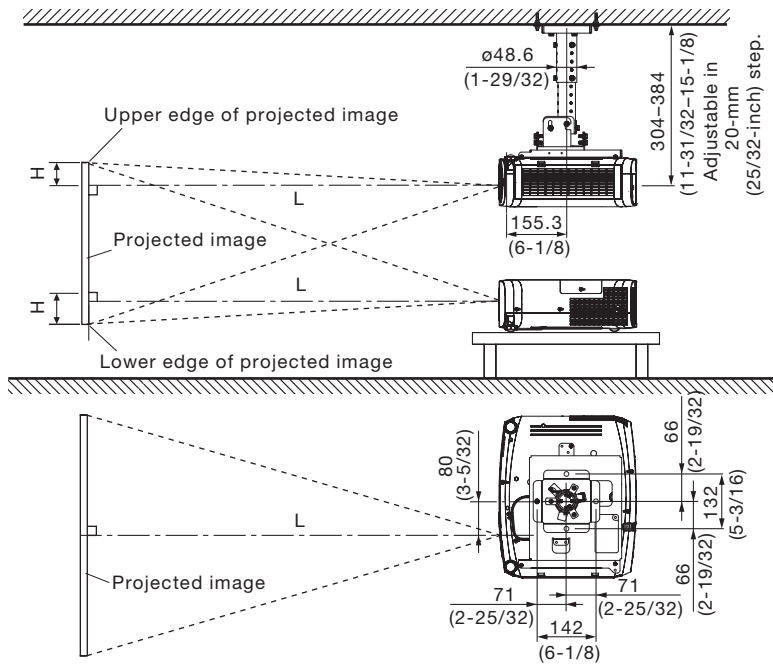

NOTE:

Illustrations show the projector installed using optional ceiling mount bracket ET-PKL100H and projector mount bracket ET-PKV400B.

This illustration is not drawn to scale.

unit : mm (inch)

Caution:

- All construction work should be done by a qualified technician.
- When mounting to the ceiling, use the special mounting bracket. To prevent the projector from dropping, attach the wire that is included with the projector between the mounting bracket and the ceiling.

Projection distance for 16:10 aspect ratio screen

unit: meters (feet)

Projection size [diagonal]	Projection distance [L]		Height from the edge of screen to center of lens [H]	
	Min [wide]	Max [telephoto]		
0.76 m / 30"	0.68 (2.23)	1.12 (3.67)	0.022 – 0.201	(0.072 – 0.659)
1.02 m / 40"	0.93 (3.05)	1.51 (4.95)	0.030 – 0.270	(0.098 – 0.886)
1.27 m / 50"	1.16 (3.81)	1.89 (6.20)	0.037 – 0.337	(0.121 – 1.106)
1.52 m / 60"	1.39 (4.56)	2.26 (7.41)	0.045 – 0.403	(0.148 – 1.322)
1.78 m / 70"	1.64 (5.38)	2.66 (8.73)	0.052 – 0.472	(0.171 – 1.549)
2.03 m / 80"	1.87 (6.14)	3.03 (9.94)	0.060 – 0.538	(0.197 – 1.765)
2.29 m / 90"	2.12 (6.96)	3.43 (11.25)	0.067 – 0.607	(0.220 – 1.991)
2.54 m / 100"	2.35 (7.71)	3.80 (12.47)	0.075 – 0.673	(0.246 – 2.208)
3.05 m / 120"	2.83 (9.28)	4.57 (14.99)	0.090 – 0.808	(0.295 – 2.651)
3.81 m / 150"	3.54 (11.61)	5.72 (18.77)	0.112 – 1.010	(0.367 – 3.314)
5.08 m / 200"	4.73 (15.52)	7.64 (25.07)	0.150 – 1.346	(0.492 – 4.416)
6.35 m / 250"	5.92 (19.42)	9.56 (31.36)	0.187 – 1.683	(0.614 – 5.522)
7.62 m / 300"	7.11 (23.33)	11.48 (37.66)	0.224 – 2.019	(0.735 – 6.624)

NOTE:

- The value for L (distance to screen) varies slightly depending on the zoom lens characteristics.
- At the shortest projection distance, the zoom lens characteristics may cause slight image distortion.

**Projection distance for 16:9 aspect ratio screen**

unit: meters (feet)

Projection size [diagonal]	Projection distance [L]		Height from the edge of screen to center of lens [H]	
	Min [wide]	Max [telephoto]		
0.76 m / 30"	0.70 (2.30)	1.15 (3.77)	0.002 – 0.186 (0.007 – 0.610)	
1.02 m / 40"	0.95 (3.12)	1.55 (5.09)	0.003 – 0.250 (0.010 – 0.820)	
1.27 m / 50"	1.19 (3.90)	1.94 (6.36)	0.004 – 0.311 (0.013 – 1.020)	
1.52 m / 60"	1.43 (4.69)	2.33 (7.64)	0.005 – 0.372 (0.016 – 1.220)	
1.78 m / 70"	1.69 (5.54)	2.73 (8.96)	0.005 – 0.436 (0.016 – 1.430)	
2.03 m / 80"	1.93 (6.33)	3.12 (10.24)	0.006 – 0.497 (0.020 – 1.631)	
2.29 m / 90"	2.18 (7.15)	3.52 (11.55)	0.007 – 0.561 (0.023 – 1.841)	
2.54 m / 100"	2.42 (7.94)	3.91 (12.83)	0.008 – 0.622 (0.026 – 2.041)	
3.05 m / 120"	2.91 (9.55)	4.70 (15.42)	0.009 – 0.747 (0.030 – 2.451)	
3.81 m / 150"	3.64 (11.94)	5.88 (19.29)	0.012 – 0.933 (0.039 – 3.061)	
5.08 m / 200"	4.86 (15.94)	7.85 (25.75)	0.015 – 1.245 (0.049 – 4.085)	
6.35 m / 250"	6.09 (19.98)	9.83 (32.25)	0.019 – 1.556 (0.062 – 5.105)	
7.62 m / 300"	7.31 (23.98)	11.80 (38.71)	0.023 – 1.867 (0.075 – 6.125)	

**NOTE:**

- The value for L (distance to screen) varies slightly depending on the zoom lens characteristics.
- At the shortest projection distance, the zoom lens characteristics may cause slight image distortion.

**Projection distance for 4:3 aspect ratio screen**

unit: meters (feet)

Projection size [diagonal]	Projection distance [L]		Height from the edge of screen to center of lens [H]	
	Min [wide]	Max [telephoto]		
0.76 m / 30"	0.78 (2.56)	1.27 (4.17)	0.025 – 0.228 (0.082 – 0.748)	
1.02 m / 40"	1.05 (3.44)	1.71 (5.61)	0.034 – 0.306 (0.112 – 1.004)	
1.27 m / 50"	1.32 (4.33)	2.14 (7.02)	0.042 – 0.381 (0.138 – 1.250)	
1.52 m / 60"	1.58 (5.18)	2.57 (8.43)	0.051 – 0.456 (0.167 – 1.496)	
1.78 m / 70"	1.86 (6.10)	3.01 (9.88)	0.059 – 0.534 (0.194 – 1.752)	
2.03 m / 80"	2.12 (6.96)	3.44 (11.29)	0.068 – 0.609 (0.223 – 1.998)	
2.29 m / 90"	2.40 (7.87)	3.88 (12.73)	0.076 – 0.687 (0.249 – 2.254)	
2.54 m / 100"	2.67 (8.76)	4.31 (14.14)	0.085 – 0.762 (0.279 – 2.500)	
3.05 m / 120"	3.21 (10.53)	5.18 (16.99)	0.102 – 0.915 (0.335 – 3.002)	
3.81 m / 150"	4.01 (13.16)	6.48 (21.26)	0.127 – 1.143 (0.417 – 3.750)	
5.08 m / 200"	5.36 (17.59)	8.65 (28.38)	0.169 – 1.524 (0.554 – 5.000)	
6.35 m / 250"	6.71 (22.01)	10.83 (35.53)	0.212 – 1.905 (0.696 – 6.250)	
7.62 m / 300"	8.05 (26.41)	13.00 (42.65)	0.254 – 2.286 (0.833 – 7.500)	

**NOTE:**

- The value for L (distance to screen) varies slightly depending on the zoom lens characteristics.
- At the shortest projection distance, the zoom lens characteristics may cause slight image distortion.

**Calculation of the projection distance**

For a screen size different from the above, use the equation below to calculate the projection distance.

Aspect ratio 16:10

minimum L (m) = (diagonal screen size in inches) × 0.0238 – 0.0294

maximum L (m) = (diagonal screen size in inches) × 0.0384 – 0.0319

Aspect ratio 16:9

minimum L (m) = (diagonal screen size in inches) × 0.0245 – 0.0294

maximum L (m) = (diagonal screen size in inches) × 0.0394 – 0.0319

Aspect ratio 4:3

minimum L (m) = (diagonal screen size in inches) × 0.0269 – 0.0294

maximum L (m) = (diagonal screen size in inches) × 0.0434 – 0.0319

**NOTE:**

Distances calculated with the above equations will include a slight error.

**Shift range**

Optical axis shift function allows to shift the position of a projected image as shown below.

• **Floor mount**

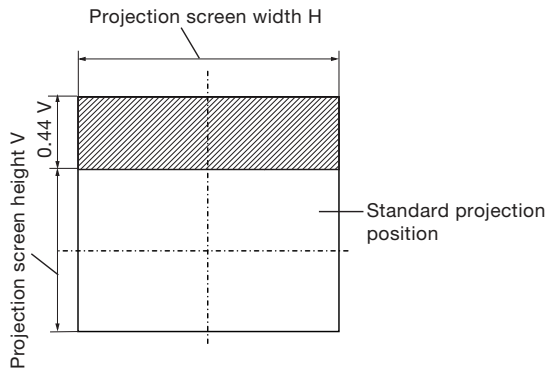

• **Ceiling mount**

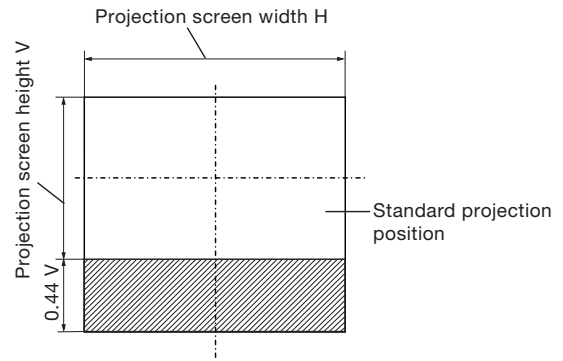

**Installable angle**

Install the projector at an angle within the range shown below.

• **Vertical direction**

The projector may be installed at a vertical angle of 30°.

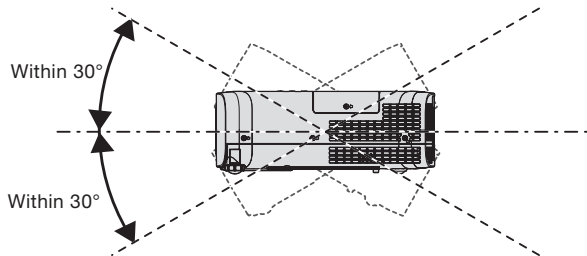

• **Horizontal direction**

The projector may be installed at a horizontal angle of 15°.

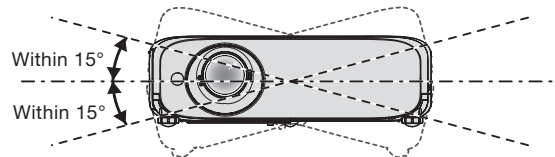



**List of compatible signals**

The following table specifies the video signals compatible with the projector. This projector supports the signal with I in the compatible signal column.

- Symbols that indicate formats are as follows.

--V: VIDEO  
 --R: RGB  
 --Y: Y<sub>C</sub>CR/Y<sub>P</sub>BR  
 --H: HDMI

- Input corresponding to each item in the plug and play column is as follows.

--COMPUTER: COMPUTER1 / COMPUTER2 input  
 --HDMI/DL: HDMI1 / HDMI2 input

Compatible signal	Resolution (Dots)	Scanning freq.		Dot clock freq. (MHz)	Format	Plug and Play*1	
		H (KHz)	V (Hz)			COMPUTER	HDMI/DL
NTSC/NTSC4.43/PAL-M/PAL60	720 x 480i	15.7	59.9	—	V/S	—	—
PAL/PAL-N/SECAM	720 x 576i	15.6	50.0	—	V/S	—	—
480/60i	720 x 480i	15.7	59.9	13.5	R/Y	—	—
576/50i	720 x 576i	15.6	50.0	13.5	R/Y	—	—
480/60i	720(1440)x 480i*2	15.7	59.9	27.0	H	—	—
576/50i	720(1440)x 576i*2	15.6	50.0	27.0	H	—	—
480/60p	720 x 480	31.5	59.9	27.0	R/Y/H	—	✓
576/50p	720 x 576	31.3	50.0	27.0	R/Y/H	—	✓
720/60p	1280 x 720	45.0	60.0	74.3	R/Y/H	—	✓
720/50p	1280 x 720	37.5	50.0	74.3	R/Y/H	—	✓
1080/60i	1920 x 1080i	33.8	60.0	74.3	R/Y/H	—	✓
1080/50i	1920 x 1080i	28.1	50.0	74.3	R/Y/H	—	✓
1080/24p	1920 x 1080	27.0	24.0	74.3	R/Y/H	—	✓
1080/24sF	1920 x 1080i	27.0	48.0	74.3	R/Y/H	—	—
1080/25p	1920 x 1080	28.1	25.0	74.3	R/Y/H	—	—
1080/30p	1920 x 1080	33.8	30.0	74.3	R/Y/H	—	—
1080/60p	1920 x 1080	67.5	60.0	148.5	R/Y/H	—	✓
1080/50p	1920 x 1080	56.3	50.0	148.5	R/Y/H	—	✓
640 x 400/70	640 x 400	31.5	70.1	25.2	R/H	—	—
640 x 400/85	640 x 400	37.9	85.1	31.5	R/H	—	—
640 x 480/60	640 x 480	31.5	59.9	25.2	R/H	✓	✓
640 x 480/67	640 x 480	35.0	66.7	30.2	R/H	—	—
640 x 480/73	640 x 480	37.9	72.8	31.5	R/H	✓	✓
640 x 480/75	640 x 480	37.5	75.0	31.5	R/H	✓	✓
640 x 480/85	640 x 480	43.3	85.0	36.0	R/H	—	—
800 x 600/56	800 x 600	35.2	56.3	36.0	R/H	✓	✓
800 x 600/60	800 x 600	37.9	60.3	40.0	R/H	✓	✓
800 x 600/72	800 x 600	48.1	72.2	50.0	R/H	✓	✓
800 x 600/75	800 x 600	46.9	75.0	49.5	R/H	✓	✓
800 x 600/85	800 x 600	53.7	85.1	56.3	R/H	—	—
832 x 624/75	832 x 624	49.7	74.6	57.3	R/H	✓	✓
1024 x 768/50	1024 x 768	39.6	50.0	51.9	R/H	—	—
1024 x 768/60	1024 x 768	48.4	60.0	65.0	R/H	✓	✓
1024 x 768/70	1024 x 768	56.5	70.1	75.0	R/H	✓	✓
1024 x 768/75	1024 x 768	60.0	75.0	78.8	R/H	✓	✓
1024 x 768/82	1024 x 768	65.5	81.6	86.0	R/H	—	—
1024 x 768/85	1024 x 768	68.7	85.0	94.5	R/H	—	—
1024 x 768/100	1024 x 768	81.4	100.0	113.3	R/H	—	—
1152 x 864/60	1152 x 864	53.7	60.0	81.6	R/H	—	—
1152 x 864/75	1152 x 864	67.5	75.0	108.0	R/H	—	—
1152 x 864/85	1152 x 864	77.1	85.0	119.7	R/H	—	—
1152 x 870/75	1152 x 870	68.7	75.1	100.0	R/H	✓	✓
1280 x 720/50	1280 x 720	37.1	49.8	60.5	R/H	—	—
1280 x 720/60	1280 x 720	44.8	59.9	74.5	R/H	—	—

Compatible signal	Resolution (Dots)	Scanning freq.		Dot clock freq. (MHz)	Format	Plug and Play*1	
		H (KHz)	V (Hz)			COMPUTER	HDMI/DL
1280 x 768/60*3	1280 x 768	47.7	60.0	80.1	R/H	—	—
1280 x 768/60	1280 x 768	47.8	59.9	79.5	R/H	—	—
1280 x 768/75	1280 x 768	60.3	74.9	102.3	R/H	—	—
1280 x 768/85	1280 x 768	68.6	84.8	117.5	R/H	—	—
1280 x 800/50	1280 x 800	41.3	50.0	68.0	R/H	—	—
1280 x 800/60	1280 x 800	49.7	59.8	83.5	R/H	—	—
1280 x 800/75	1280 x 800	62.8	74.9	106.5	R/H	—	—
1280 x 800/85	1280 x 800	71.6	84.9	122.5	R/H	—	—
1280 x 960/60	1280 x 960	60.0	60.0	108.0	R/H	—	—
1280 x 1024/60	1280 x 1024	64.0	60.0	108.0	R/H	—	—
1280 x 1024/75	1280 x 1024	80.0	75.0	135.0	R/H	✓	✓
1280 x 1024/85	1280 x 1024	91.1	85.0	157.5	R/H	—	—
1366 x 768/50	1366 x 768	39.6	49.9	69.0	R/H	—	—
1366 x 768/60*3	1366 x 768	47.7	60.0	84.7	R/H	—	—
1366 x 768/60	1366 x 768	47.7	59.8	85.5	R/H	—	—
1400 x 1050/60*3	1400 x 1050	65.2	60.0	122.6	R/H	—	—
1400 x 1050/60	1400 x 1050	65.3	60.0	121.8	R/H	—	—
1400 x 1050/75	1400 x 1050	82.2	75.0	155.9	R/H	—	—
1440 x 900/50*3	1440 x 900	46.3	50.0	87.4	R/H	—	—
1440 x 900/60*3	1440 x 900	55.9	60.0	106.5	R/H	—	—
1440 x 900/60	1440 x 900	55.9	59.9	106.5	R/H	—	—
1600 x 900/50*3	1600 x 900	46.3	50.0	97.0	R/H	—	—
1600 x 900/60*3	1600 x 900	55.9	60.0	119.0	R/H	—	—
1600 x 1200/60	1600 x 1200	75.0	60.0	162.0	R/H	✓	✓
1680 x 1050/50	1680 x 1050	54.1	50.0	119.5	R/H	—	—
1680 x 1050/60*3	1680 x 1050	65.2	60.0	147.1	R/H	—	—
1680 x 1050/60	1680 x 1050	65.3	60.0	146.3	R/H	—	—
1920 x 1080/50	1920 x 1080	55.6	49.9	141.5	R/H	—	—
1920 x 1080/60*4	1920 x 1080	66.6	59.9	138.5	R/H	—	—
1920 x 1080/60*5	1920 x 1080	67.2	60.0	173.0	C	—	—
1920 x 1200/50	1920 x 1200	61.8	49.9	158.3	R/H	—	—
1920 x 1200/60*4	1920 x 1200	74.0	60.0	154.0	R/H	✓	✓
1920 x 1200/60*5	1920 x 1200	74.6	59.9	193.3	C	—	—

\*1 Signal with I in the plug and play column is a signal described in the EDID (extended display identification data) of the projector. The signal that does not have I in the plug and play column can also be input if it is described in the format column. The resolution may not be selected in the computer even if the projector is compatible with the signal that does not have I in the plug and play column.

\*2 Pixel-Repetition signal (dot clock frequency 27.0 MHz) only

\*3 If pertinent analog signal is input, it can be displayed when the setting suitable for the signal is made on [PICTURE] menu → [RGB SYSTEM]. It is no need to setting when input the digital signal.

\*4 VESA CVT-RB (Reduced Blanking)-compliant

\*5 Samples the pixels in the image processing circuit and displays the image.

**NOTE:**

- A signal with a different resolution is converted to the number of display dots. The number of display dots is as follows.  
1920 x 1200
- The "i" at the end of the resolution indicates an interlaced signal.
- When interlaced signals are connected, flickering may occur on the projected image.
- Even the above signals exist, some image signals recorded in special method may not be displayed.

**Notes on projector placement and operation**

The projector uses a high-wattage lamp that becomes very hot during operation. Please observe the following precautions.

1. Never place objects on top of the projector while it is operating.
2. Make sure there is the unobstructed space as shown below or more around the projector's exhaust openings. In addition to this space, also ensure that there is a sufficient work space for removing and installing the lamp, filter and other parts.
3. Make sure that nothing blocks the projector's air intake and exhaust openings. Also, install the projector so that cool or hot air from other air conditioning equipment does not flow directly toward the projector's air intake or exhaust openings.
4. Do not install the projector in an enclosed space. If it is necessary to install it in an enclosed space, add a separate ventilation system. If ventilation is insufficient, hot air will accumulate at the intake opening. This may cause the projector's protective circuit to interrupt projector operation.

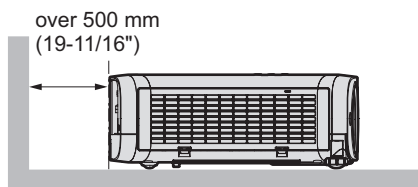
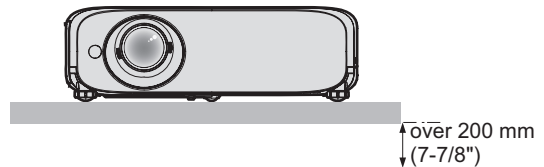
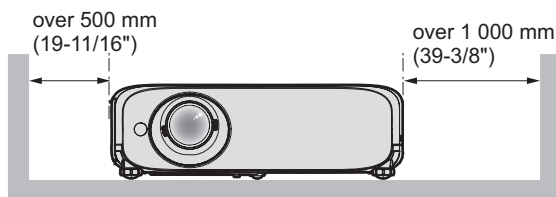
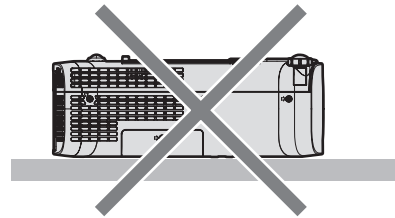
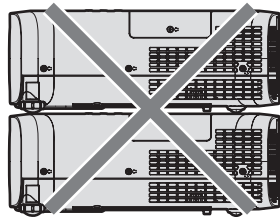

**Direction of air intake and exhaust**

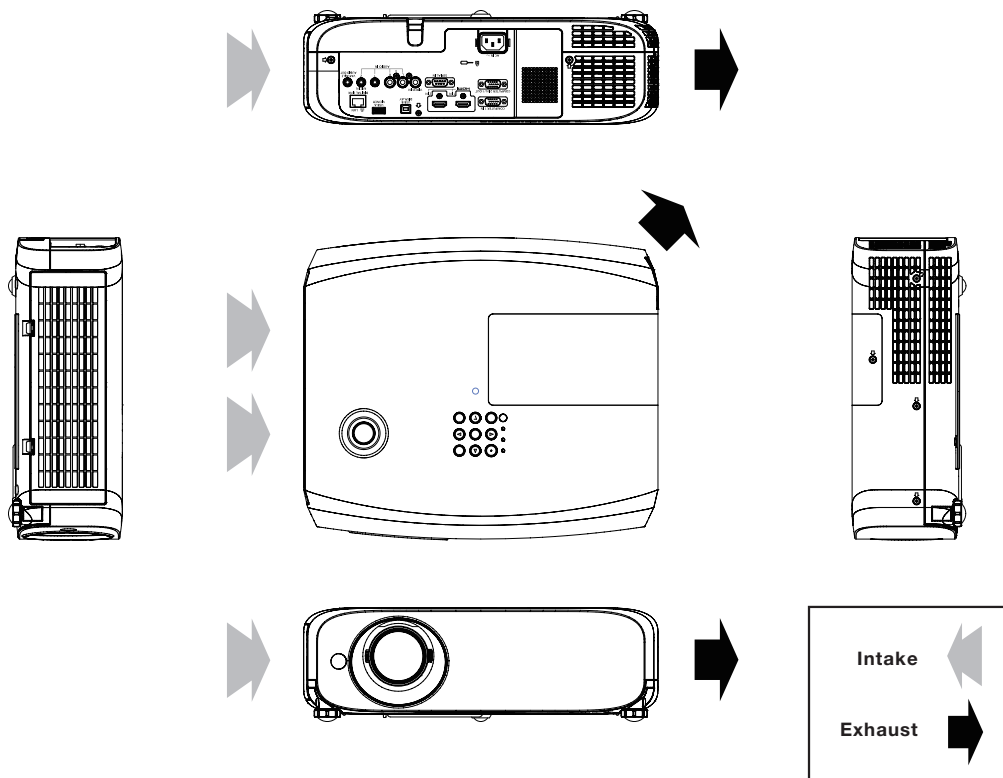

**Operating the projector continuously**

1. If the projector is to be operated continuously 12 hours or more, lamp replacement cycle duration becomes shorter.
2. The lamp replacement cycle duration becomes shorter if the projector is operated repeatedly for short periods (one hour or less).

Weights and dimensions shown are approximate. Specifications and appearance are subject to change without notice. Product availability differs depending on region and country. This product may be subject to export control regulations.

HDMI, the HDMI logo and High-Definition Multimedia Interface are trademarks or registered trademarks of HDMI Licensing LLC in the United States and other countries. PJLink is a registered trademark, or a trademark application has been filed, in Japan, the United States, and other countries and regions. All other trademarks are the property of their respective trademark owners.