

Zoom Lens

This zoom lens is designed for use with Panasonic’s applicable projectors. The lens makes it possible to vary the projection distance by changing the focal distance.

**NOTE:** Please use the lens only on the specified Panasonic projector.

**Specifications**

F value:	2.5
Focal distance (f):	50.4– 98.0 mm
Throw ratio:	2.57-5.00:1 for PT-RQ32K/RQ22K (16:10 aspect ratio) 2.40-4.66:1 for PT-RZ31K/RZ21K (16:10 aspect ratio) 2.59-5.05:1 for PT-RS30K/RS20K (4:3 aspect ratio)
Auto Lens Identification Function	Compatible models : PT-RQ32K/RZ31K/RS30K/RQ22K/RZ21K/RS20K
Dimensions (W × H × D):	154 × 154 × 322mm (6-1/16 × 6-1/16 × 12-11/16 inches) (without protrusion parts)
Weight:	Approximately 5.8 kg* (12.8 lbs*)
Applicable projector	[Group A] PT-RZ21K/RS20K PT-RQ22K [Group B] PT-RZ31K/RS30K PT-RQ32K
	----- PT-RQ35K/RZ34K/RZ16K For these projectors see the individual spec files of the projectors

\*Average value. May differ depending on the actual unit.  
The throw ratio is an approximate value calculated by dividing the screen width by the projection distance.

**Dimensions**

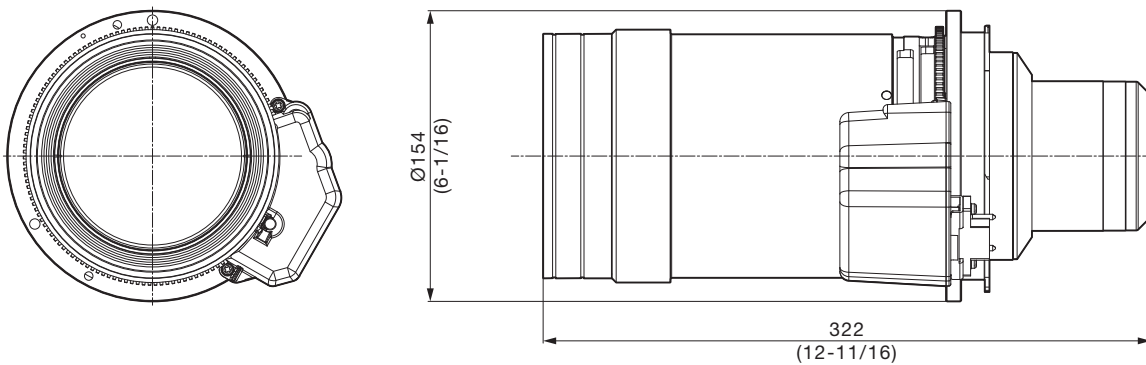

unit : mm (inch)  
**NOTE:** This illustration is not drawn to scale.

**NOTE:** Weights and dimensions shown are approximate. Specifications subject to change without notice.

[Group A]

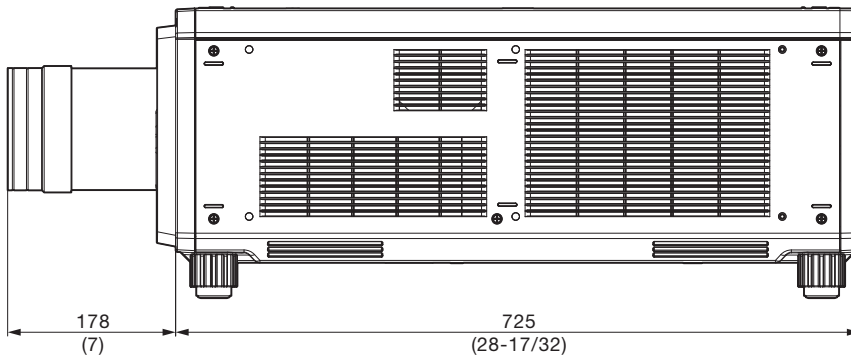

[Group B]

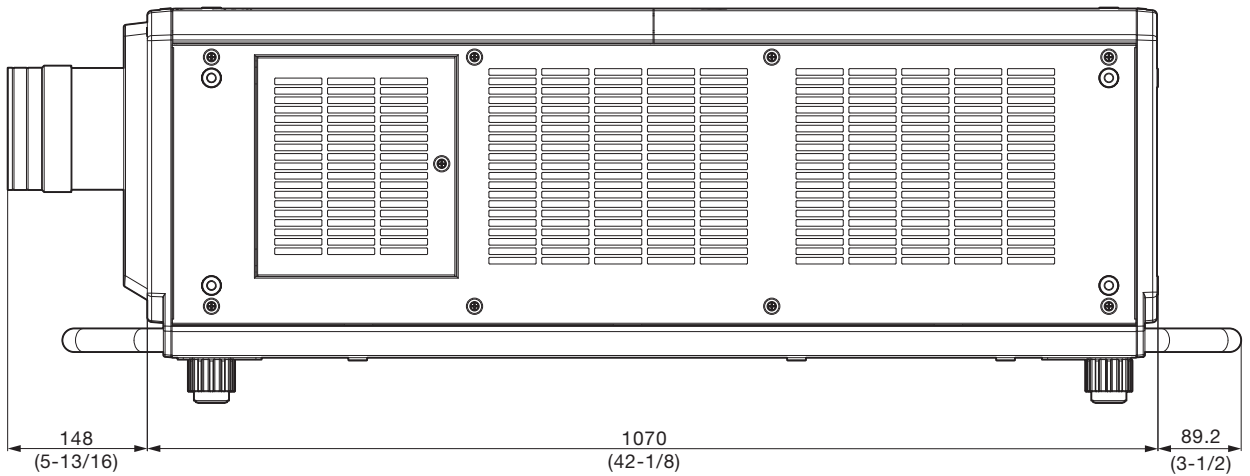

unit : mm (inch)  
 NOTE: This illustration is not drawn to scale.

NOTE: Weights and dimensions shown are approximate. Specifications subject to change without notice.

## Zoom Lens

### Projection relationships

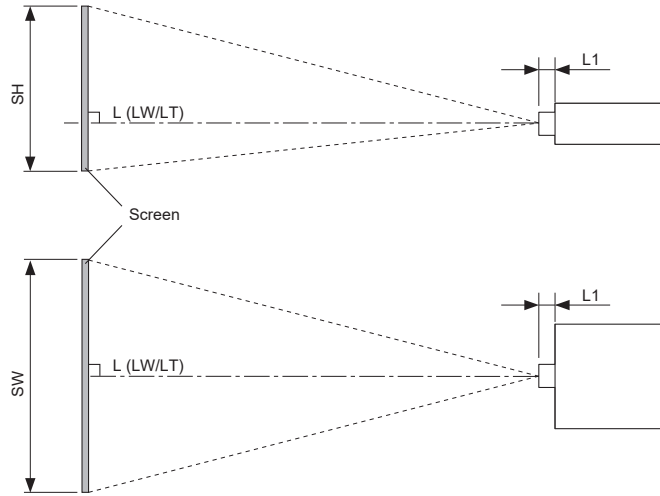
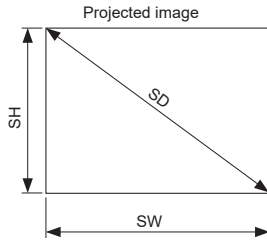

- NOTE**
- This diagram assumes that the size and position of the projected image will be adjusted so that the image fills the entire screen.
  - This illustration is not drawn to scale.

L	Projection distance
	LW Minimum distance
	LT Maximum distance
L1	Lens protrusion dimension
SH	Projected image height
SW	Projected image width
SD	Projected image size

(Unit: m)

Projector model	Dimension for L1 (approximate value)
PT-RQ22K/RZ21K/RS20K	0.18
PT-RQ32K/RZ31K/RS30K	0.15

### Projection distance

PT-RQ32K/R22K/RZ31K/RZ21K  
Aspect ratio 16:10

unit: meters (feet)

Projection size (Diagonal) [SD]	Projection size (Height) [SH]	Projection size (Width) [SW]	PT-RQ32K/RQ22K (2560×1600) Throw ratio[2.57-5.00:1]		PT-RZ31K/RZ21K (WUXGA; 1920×1200) Throw ratio[2.40-4.66:1]	
			Min [LW]	Max [LT]	Min [LW]	Max [LT]
			1.778 m / 70"	0.942 (3.09)	1.508 (4.95)	3.80 (12.5)
2.032 m / 80"	1.077 (3.53)	1.723 (5.65)	4.36 (14.3)	8.54 (28.0)	4.06 (13.3)	7.96 (26.1)
2.286 m / 90"	1.212 (3.98)	1.939 (6.36)	4.92 (16.1)	9.63 (31.6)	4.59 (15.1)	8.97 (29.4)
2.540 m / 100"	1.346 (4.42)	2.154 (7.07)	5.48 (18.0)	10.72 (35.2)	5.11 (16.8)	9.99 (32.8)
3.048 m / 120"	1.615 (5.30)	2.585 (8.48)	6.60 (21.7)	12.90 (42.3)	6.16 (20.2)	12.03 (39.5)
3.810 m / 150"	2.019 (6.62)	3.231 (10.60)	8.29 (27.2)	16.17 (53.1)	7.73 (25.4)	15.08 (49.5)
5.080 m / 200"	2.692 (8.83)	4.308 (14.13)	11.09 (36.4)	21.63 (71.0)	10.34 (33.9)	20.17 (66.2)
6.350 m / 250"	3.365 (11.04)	5.385 (17.67)	13.90 (45.6)	27.08 (88.8)	12.96 (42.5)	25.26 (82.9)
7.620 m / 300"	4.039 (13.25)	6.462 (21.20)	16.70 (54.8)	32.54 (106.8)	15.58 (51.1)	30.35 (99.6)
8.890 m / 350"	4.712 (15.46)	7.539 (24.73)	19.50 (64.0)	37.99 (124.6)	18.20 (59.7)	35.45 (116.3)
10.160 m / 400"	5.385 (17.67)	8.616 (28.27)	22.31 (73.2)	43.44 (142.5)	20.81 (68.3)	40.54 (133.0)
12.700 m / 500"	6.731 (22.08)	10.770 (35.33)	27.92 (91.6)	54.35 (178.3)	26.05 (85.5)	50.72 (166.4)
15.240 m / 600"	8.077 (26.50)	12.923 (42.40)	33.52(110.0)	65.26 (214.1)	31.28(102.6)	60.90 (199.8)
17.780 m / 700"	9.423 (30.92)	15.077 (49.47)	39.13(128.4)	76.17 (249.9)	36.52(119.8)	71.08 (233.2)
20.320 m / 800"	10.770 (35.33)	17.231 (56.53)	44.74(146.8)	87.08 (285.7)	41.75(137.0)	81.26 (266.6)
22.860 m / 900"	12.116 (39.75)	19.385 (63.60)	50.35(165.2)	97.99 (321.5)	46.99(154.2)	91.44 (300.0)
25.400 m /1000"	13.462 (44.17)	21.539 (70.67)	55.96(183.6)	108.90 (357.3)	52.22(171.3)	101.62 (333.4)

## Zoom Lens

PT-RQ32K/RQ22K/RZ31K/RZ21K/RS30K/RS20K  
Aspect ratio 16:9

unit: meters (feet)

Projection size (Diagonal) [SD]	Projection size (Height) [SH]	Projection size (Width) [SW]	PT-RQ32K/RQ22K (2560×1440)		PT-RZ31K/RZ21K (1920×1080)		PT-RS30K/RS20K (1440×788)	
			Throw ratio[2.57-5.00:1]		Throw ratio[2.40-4.66:1]		Throw ratio[2.60-5.06:1]	
			Min [LW]	Max [LT]	Min [LW]	Max [LT]	Min [LW]	Max [LT]
1.778 m / 70"	0.872 (2.86)	1.550 (5.09)	3.91 (12.8)	7.66 (25.1)	3.64 (11.9)	7.14 (23.4)	3.95 (13.0)	7.74 (25.4)
2.032 m / 80"	0.996 (3.27)	1.771 (5.81)	4.49 (14.7)	8.78 (28.8)	4.18 (13.7)	8.18 (26.8)	4.53 (14.9)	8.87 (29.1)
2.286 m / 90"	1.121 (3.68)	1.992 (6.54)	5.06 (16.6)	9.90 (32.5)	4.72 (15.5)	9.23 (30.3)	5.12 (16.8)	10.01 (32.8)
2.540 m / 100"	1.245 (4.08)	2.214 (7.26)	5.64 (18.5)	11.02 (36.2)	5.25 (17.2)	10.28 (33.7)	5.70 (18.7)	11.14 (36.5)
3.048 m / 120"	1.494 (4.90)	2.657 (8.72)	6.79 (22.3)	13.26 (43.5)	6.33 (20.8)	12.37 (40.6)	6.86 (22.5)	13.40 (44.0)
3.810 m / 150"	1.868 (6.13)	3.321 (10.90)	8.52 (28.0)	16.63 (54.6)	7.94 (26.0)	15.51 (50.9)	8.61 (28.2)	16.80 (55.1)
5.080 m / 200"	2.491 (8.17)	4.428 (14.53)	11.40 (37.4)	22.23 (72.9)	10.63 (34.9)	20.74 (68.0)	11.52 (37.8)	22.47 (73.7)
6.350 m / 250"	3.113 (10.21)	5.535 (18.16)	14.29 (46.9)	27.84 (91.3)	13.32 (43.7)	25.97 (85.2)	14.43 (47.3)	28.13 (92.3)
7.620 m / 300"	3.736 (12.26)	6.641 (21.79)	17.17 (56.3)	33.45 (109.7)	16.01 (52.5)	31.20 (102.4)	17.35 (56.9)	33.80 (110.9)
8.890 m / 350"	4.358 (14.30)	7.748 (25.42)	20.05 (65.8)	39.05 (128.1)	18.70 (61.4)	36.44 (119.6)	20.26 (66.5)	39.46 (129.5)
10.160 m / 400"	4.981 (16.34)	8.855 (29.05)	22.93 (75.2)	44.66 (146.5)	21.39 (70.2)	41.67 (136.7)	23.17 (76.0)	45.12 (148.0)
12.700 m / 500"	6.226 (20.43)	11.069 (36.32)	28.70 (94.2)	55.87 (183.3)	26.77 (87.8)	52.13 (171.0)	29.00 (95.1)	56.45 (185.2)
15.240 m / 600"	7.472 (24.51)	13.283 (43.58)	34.46(113.1)	67.08 (220.1)	32.15(105.5)	62.60 (205.4)	34.82(114.2)	67.78 (222.4)
17.780 m / 700"	8.717 (28.60)	15.497 (50.84)	40.22(132.0)	78.29 (256.9)	37.53(123.1)	73.06 (239.7)	40.64(133.3)	79.11 (259.5)
20.320 m / 800"	9.962 (32.68)	17.710 (58.10)	45.99(150.9)	89.51 (293.7)	42.92(140.8)	83.53 (274.0)	46.47(152.5)	90.44 (296.7)
22.860 m / 900"	11.207 (36.77)	19.924 (65.37)	51.75(169.8)	100.72 (330.4)	48.30(158.5)	93.99 (308.4)	52.29(171.6)	101.76 (333.9)
25.400 m /1000"	12.453 (40.86)	22.138 (72.63)	57.52(188.7)	111.93 (367.2)	53.68(176.1)	104.45 (342.7)	58.12(190.7)	113.09 (371.0)

PT-RQ32K/RQ22K/RZ31K/RZ21K/RS30K/RS20K  
Aspect ratio 4:3

unit: meters (feet)

Projection size (Diagonal) [SD]	Projection size (Height) [SH]	Projection size (Width) [SW]	PT-RQ32K/RQ22K (2133×1600)		PT-RZ31K/RZ21K (1600×1200)		PT-RS30K/RS20K (SXGA+; 1400×1050)	
			Throw ratio[3.09-6.01:1]		Throw ratio[2.88-5.61:1]		Throw ratio[2.59-5.05:1]	
			Min [LW]	Max [LT]	Min [LW]	Max [LT]	Min [LW]	Max [LT]
1.778 m / 70"	1.067 (3.50)	1.422 (4.67)	4.32 (14.2)	8.46 (27.8)	4.02 (13.2)	7.88 (25.9)	3.62 (11.9)	7.09 (23.3)
2.032 m / 80"	1.219 (4.00)	1.626 (5.33)	4.95 (16.2)	9.69 (31.8)	4.61 (15.1)	9.03 (29.6)	4.15 (13.6)	8.13 (26.7)
2.286 m / 90"	1.372 (4.50)	1.829 (6.00)	5.59 (18.3)	10.93 (35.9)	5.21 (17.1)	10.18 (33.4)	4.69 (15.4)	9.17 (30.1)
2.540 m / 100"	1.524 (5.00)	2.032 (6.67)	6.22 (20.4)	12.16 (39.9)	5.80 (19.0)	11.34 (37.2)	5.22 (17.1)	10.21 (33.5)
3.048 m / 120"	1.829 (6.00)	2.438 (8.00)	7.49 (24.6)	14.63 (48.0)	6.99 (22.9)	13.64 (44.8)	6.29 (20.6)	12.29 (40.3)
3.810 m / 150"	2.286 (7.50)	3.048 (10.00)	9.40 (30.8)	18.34 (60.2)	8.76 (28.7)	17.10 (56.1)	7.89 (25.9)	15.41 (50.6)
5.080 m / 200"	3.048 (10.00)	4.064 (13.33)	12.57 (41.2)	24.51 (80.4)	11.73 (38.5)	22.86 (75.0)	10.57 (34.7)	20.61 (67.6)
6.350 m / 250"	3.810 (12.50)	5.080 (16.67)	15.75 (51.7)	30.69 (100.7)	14.69 (48.2)	28.63 (93.9)	13.24 (43.4)	25.81 (84.7)
7.620 m / 300"	4.572 (15.00)	6.096 (20.00)	18.92 (62.1)	36.86 (120.9)	17.65 (57.9)	34.39 (112.8)	15.91 (52.2)	31.01 (101.7)
8.890 m / 350"	5.334 (17.50)	7.112 (23.33)	22.10 (72.5)	43.04 (141.2)	20.61 (67.6)	40.15 (131.7)	18.59 (61.0)	36.21 (118.8)
10.160 m / 400"	6.096 (20.00)	8.128 (26.67)	25.27 (82.9)	49.21 (161.5)	23.58 (77.4)	45.91 (150.6)	21.26 (69.8)	41.41 (135.9)
12.700 m / 500"	7.620 (25.00)	10.160 (33.33)	31.62(103.7)	61.56 (202.0)	29.50 (96.8)	57.44 (188.5)	26.61 (87.3)	51.81 (170.0)
15.240 m / 600"	9.144 (30.00)	12.192 (40.00)	37.97(124.6)	73.91 (242.5)	35.43(116.2)	68.97 (226.3)	31.95(104.8)	62.21 (204.1)
17.780 m / 700"	10.668 (35.00)	14.224 (46.67)	44.32(145.4)	86.26 (283.0)	41.36(135.7)	80.49 (264.1)	37.30(122.4)	72.61 (238.2)
20.320 m / 800"	12.192 (40.00)	16.256 (53.33)	50.67(166.2)	98.62 (323.6)	47.28(155.1)	92.02 (301.9)	42.65(139.9)	83.01 (272.3)
22.860 m / 900"	13.716 (45.00)	18.288 (60.00)	57.02(187.1)	110.97 (364.1)	53.21(174.6)	103.54 (339.7)	47.99(157.4)	93.41 (306.5)
25.400 m /1000"	15.240 (50.00)	20.320 (66.67)	63.37(207.9)	123.32 (404.6)	59.13(194.0)	115.07 (377.5)	53.34(175.0)	103.80 (340.6)

Zoom Lens

Calculation of the projection distance

Aspect ratio 16:10

unit: meters

PT-RQ32K/RQ22K	minimum	$LW (m) = (\text{diagonal screen size in inches}) \times 0.0561 - 0.1261$
	maximum	$LT (m) = (\text{diagonal screen size in inches}) \times 0.1091 - 0.1892$
PT-RZ31K/RZ21K	minimum	$LW (m) = (\text{diagonal screen size in inches}) \times 0.0523 - 0.1261$
	maximum	$LT (m) = (\text{diagonal screen size in inches}) \times 0.1018 - 0.1892$

Aspect ratio 16:9

unit: meters

PT-RQ32K/RQ22K	minimum	$LW (m) = (\text{diagonal screen size in inches}) \times 0.0576 - 0.1261$
	maximum	$LT (m) = (\text{diagonal screen size in inches}) \times 0.1121 - 0.1892$
PT-RZ31K/RZ21K	minimum	$LW (m) = (\text{diagonal screen size in inches}) \times 0.0538 - 0.1261$
	maximum	$LT (m) = (\text{diagonal screen size in inches}) \times 0.1046 - 0.1892$
PT-RS30K/RS20K	minimum	$LW (m) = (\text{diagonal screen size in inches}) \times 0.0582 - 0.1261$
	maximum	$LT (m) = (\text{diagonal screen size in inches}) \times 0.1133 - 0.1892$

Aspect ratio 4:3

unit: meters

PT-RQ32K/RQ22K	minimum	$LW (m) = (\text{diagonal screen size in inches}) \times 0.0635 - 0.1261$
	maximum	$LT (m) = (\text{diagonal screen size in inches}) \times 0.1235 - 0.1892$
PT-RZ31K/RZ21K	minimum	$LW (m) = (\text{diagonal screen size in inches}) \times 0.0593 - 0.1261$
	maximum	$LT (m) = (\text{diagonal screen size in inches}) \times 0.1153 - 0.1892$
PT-RS30K/RS20K	minimum	$LW (m) = (\text{diagonal screen size in inches}) \times 0.0535 - 0.1261$
	maximum	$LT (m) = (\text{diagonal screen size in inches}) \times 0.1040 - 0.1892$

Shift range

Optical axis shift function allows to shift the position of a projected image as shown below.

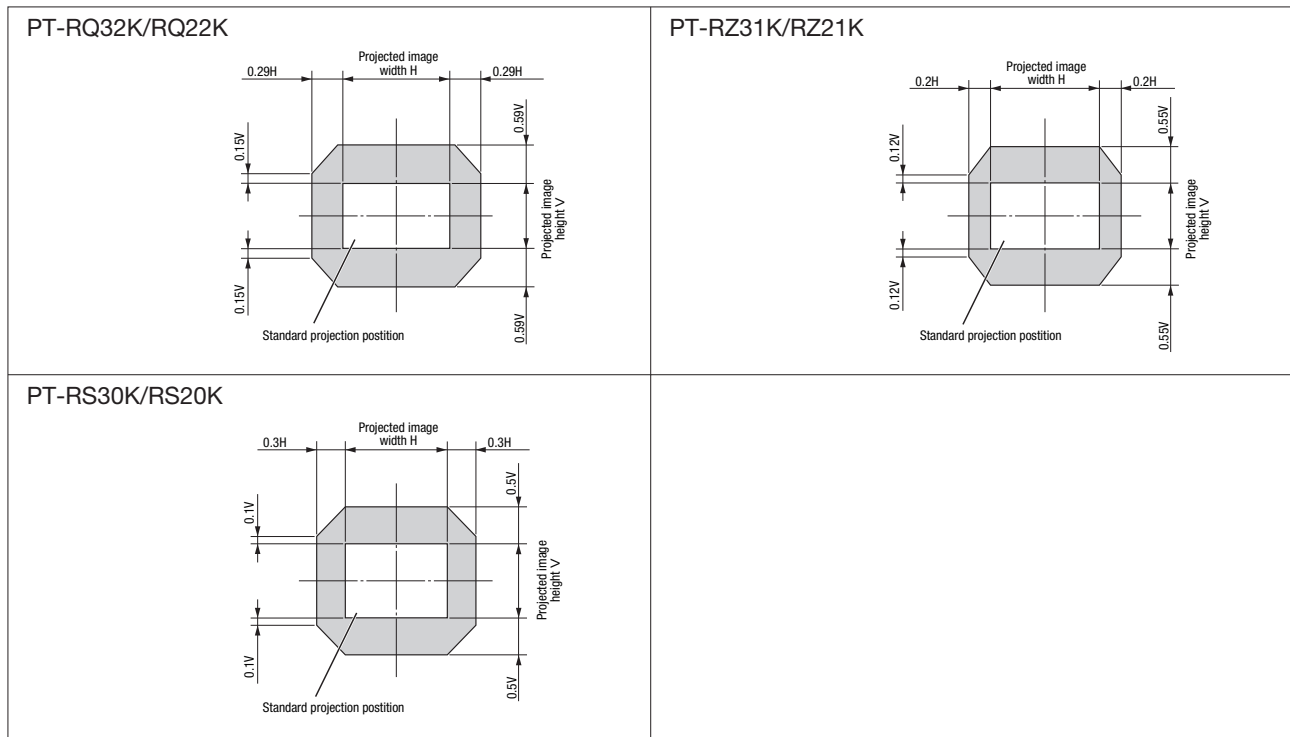

Keystone correction range

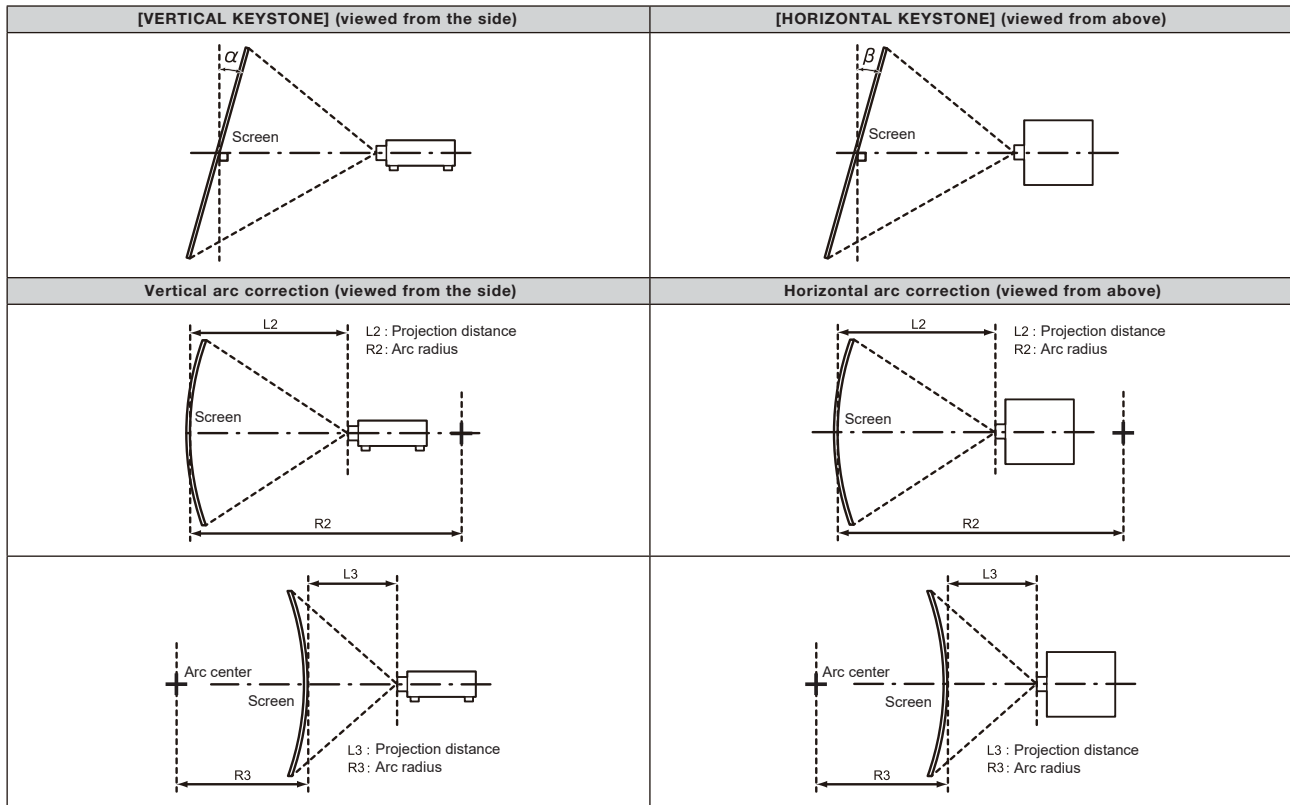

Standard status

Projector Model No.	Only [KEYSTONE] used		[KEYSTONE] and [CURVED CORRECTION] used together				Only [CURVED CORRECTION] used	
	Vertical keystone correction angle $\alpha$ (°)	Horizontal keystone correction angle $\beta$ (°)	Vertical keystone correction angle $\alpha$ (°)	Horizontal keystone correction angle $\beta$ (°)	Min. value of R2/L2	Min. value of 3/L3	Min. value of R2/L2	Min. value of R3/L3
PT-RQ32K/RQ22K	± 40	± 15	± 20	± 10	0.6	1.2	0.4	0.7
PT-RZ31K/RZ21K RS30K/RS20K	± 40	± 15	± 20	± 15	0.6	1.2	0.4	0.7

When using the optional upgrade kit (ET-UK20)

Projector Model No.	Only [KEYSTONE] used		[KEYSTONE] and [CURVED CORRECTION] used together				Only [CURVED CORRECTION] used	
	Vertical keystone correction angle $\alpha$ (°)	Horizontal keystone correction angle $\beta$ (°)	Vertical keystone correction angle $\alpha$ (°)	Horizontal keystone correction angle $\beta$ (°)	Min. value of R2/L2	Min. value of 3/L3	Min. value of R2/L2	Min. value of R3/L3
PT-RQ32K/RQ22K	± 45	± 25	± 20	± 10	0.5	0.9	0.3	0.5
PT-RZ31K/RZ21K RS30K/RS20K	± 45	± 40	± 20	± 15	0.5	0.9	0.3	0.5